



OMNEX
TRUSTED WIRELESS™

GENERIC

Installation / Configuration Manual

T110 Transmitter R160 Receiver

Revised February 9, 2007

Version 6

DMAN - xxxx - xx

#74-1833 Coast Meridian Road, Port Coquitlam, BC, Canada • V3C 6G5

Ph# (604) 944-9247 • Fax# (604) 944-9267

Toll Free 1-800-663-8806

Table of Contents

System Overview	3
Features	3
T110 Dimensions and Controls	3
Installing the Receiver.....	4
Special Functions.....	5
Installation Considerations.....	5
Power the Transmitter.....	6
Test the Transmitter / Receiver Link.....	6
Download ID Code.....	7
Changing Start Up and Shutdown Configuration.....	9
Diagnostics—T110 Transmitter	10
Diagnostics—R160 Receiver	11
Troubleshooting Guide.....	12
Parts & Accessories.....	16
Specifications.....	16
Warranty Information	16

NOTE: These instructions are intended only for installing and operating the remote control equipment described here. This is not a complete Operator's Manual. For complete operating instructions, please read the Operator's Manual appropriate for your particular machine.

Safety Precautions

READ ALL INSTRUCTIONS

CAUTION: Changes or modifications not expressly approved by the party responsible for compliance could void the user's authority to operate the equipment.

Failure to follow the SAFETY PRECAUTIONS may result in radio equipment failure and serious personal injury

Installation

PROVIDE A SAFETY CUTOFF SWITCH. If maintenance is required, the radio must be disconnected from power
USE PROPER WIRING. Loose or frayed wires can cause system failure, intermittent operation, machine damage, etc.
DO NOT INSTALL IN HOT AREAS. This apparatus can be damaged by heat in excess of 158°F (70°C)

Personal Safety

MAKE SURE MACHINERY AND SURROUNDING AREA IS CLEAR BEFORE OPERATING. Do not activate the remote system unless it is safe to do so.

TURN OFF THE RECEIVER POWER BEFORE WORKING ON MACHINERY. Always disconnect the remote system before doing any maintenance to prevent accidental operation of the machine

Care

KEEP DRY. Do not clean the transmitter / receiver under high pressure. If water or other liquids get inside the transmitter battery or receiver compartment, immediately dry the unit. Remove the case and let the unit air dry

CLEAN THE UNIT AFTER OPERATION. Remove any mud, dirt, concrete, etc. from the unit to prevent clogging of buttons, switches, etc. by using a damp cloth.

Maintenance / Welding

DISCONNECT THE RADIO RECEIVER BEFORE WELDING on the machine the receiver is connected to. Failure to disconnect will result in the destruction of the radio receiver.

System Overview

The **ORIGA T110 / R160** is a portable, long range, programmable radio remote control system. Designed as a compact and easy-to-use product, this member of the **ORIGA** family puts complete control of your machine where it's needed most, with the operator. It's robust, easy to install and has complete self-diagnostics. This system can be a simple cable replacement or add intelligence to make it a total control package. It's a radio, a PLC and a valve driver all in one.

The **ORIGA T110 / R160** system uses Frequency Hopping Spread Spectrum (FHSS) technology. FHSS devices concentrate their full power into a very narrow signal that randomly hops from frequency to frequency within a designated band. This transmission pattern, along with CRC-16 error-checking techniques, enables signals to overcome interference that commonly affects licensed radios.

The **R160 receiver** is designed to be powered from a 12VDC or 24VDC system. It features 19 solid state, high-side driver input / output controls and a reliable E-Stop control.

The ORIGA T110 comes with 4 to 10 buttons to provide the user flexibility to control the functions they need. It uses standard, long lasting AA batteries. Each T110 transmitter uses a unique ID code to ensure that no two systems will conflict at a job site.

Features

FCC, ISC, CE approved

License free

1200 foot range @ 900 MHz (900 ft. @ 2.4 GHz)

Hand held / weatherproof / ergonomic

Simple "wire-and-use" installation

Resilient to impact and shock

Available in both 900 MHz and 2.4 GHz

Available with optional E-Stop for ensured operator safety

Factory configurable for all custom applications.



R160 Receiver

T110 Transmitter

T110 Dimensions and Controls

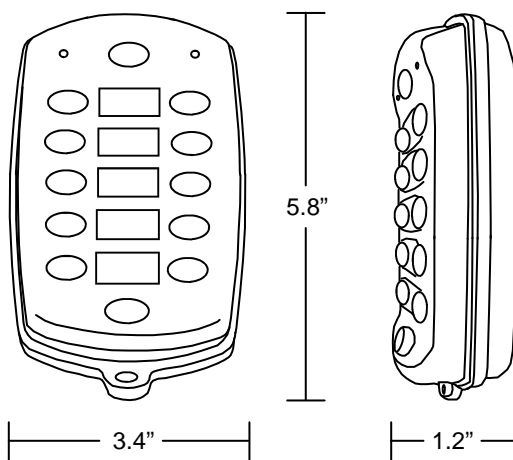

DMAN-XXXX-XX (Rev x.x)

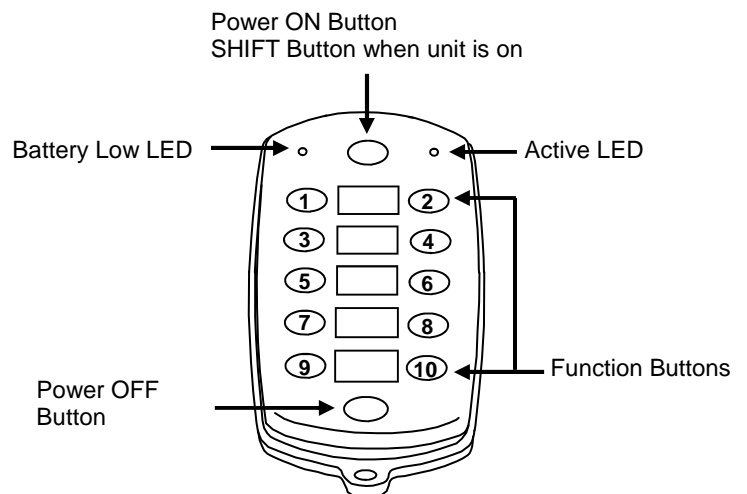

www.omnexcontrols.com

call toll free: 1-800-663-8806

Installing the Receiver

Use the **Wiring Diagram** and the **Connector Diagram** below to connect the receiver pins directly to the appropriate contacts of the machine electronics. R160 Output Cables can be provided with every system to simplify the wiring process. The Wire Color column below only applies to the OMNEX Output Cable configuration. Tips on mounting, power connections and filtering are also provided under **Installation Considerations**.

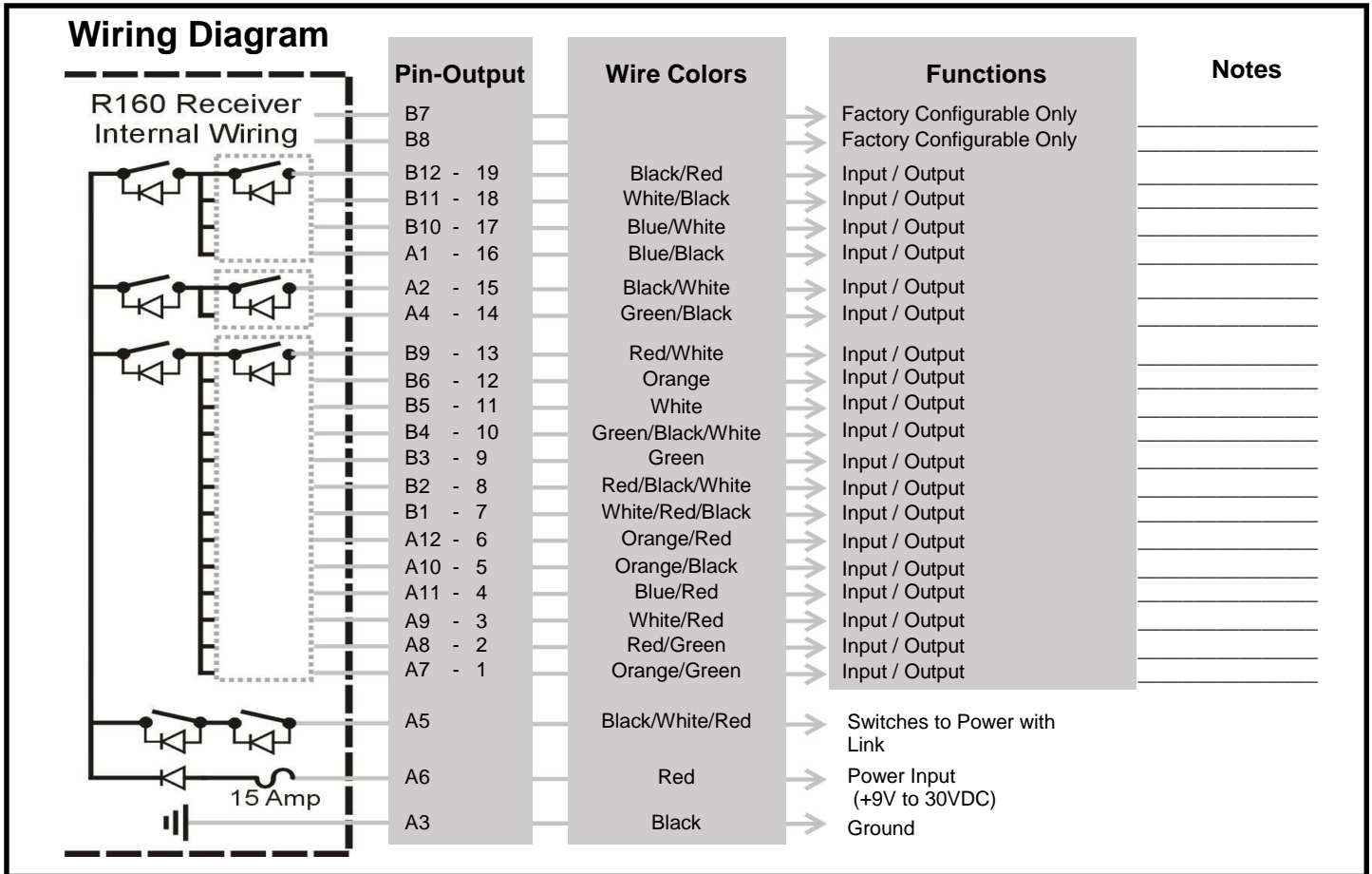

Outputs: 19 solid state, high-side driver outputs, 5A max. per pin and 7A max per bank, total combined current 15A

Inputs: All output pins can be factory configured as inputs. Input pins should be connected to a current limiting (fused) source

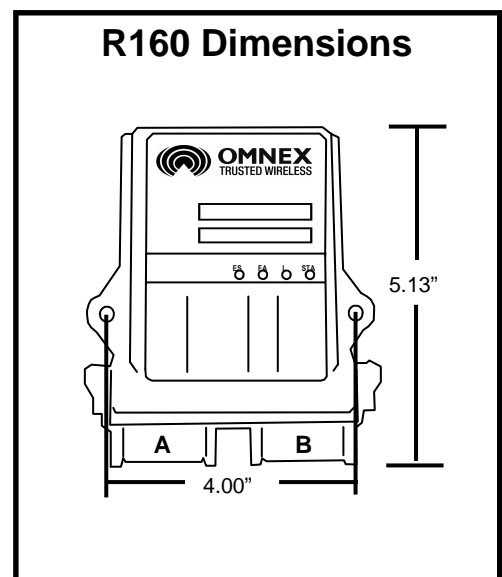
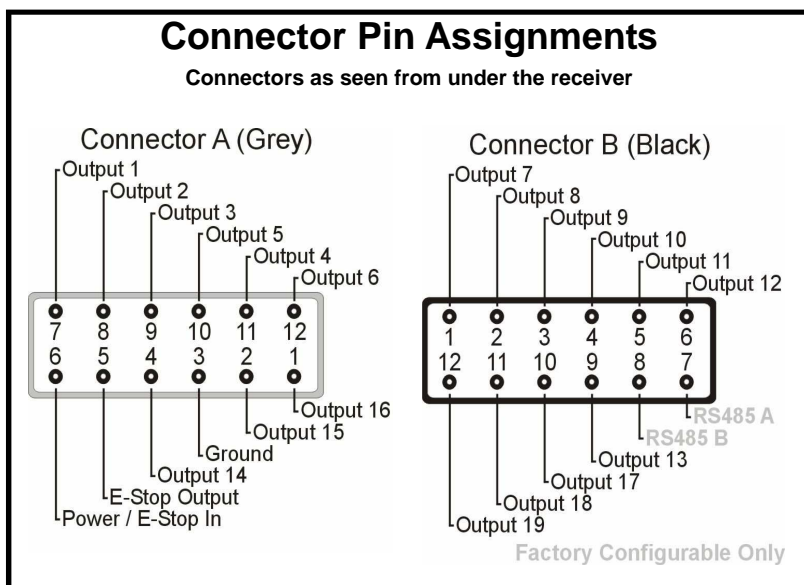

Special Functions

The [Shift] Function

Outputs 1-10 are controlled by the T110 [Function] buttons "1-10". Outputs 11-19 are controlled by holding the T110 [Shift] button and pressing the [Function] buttons "1-9" (the GREEN Power [ON] button acts as the [Shift] button when the T110 is on).

Installation Considerations

NOTE: The FCC and ISC require that the antenna be restricted to that supplied by the manufacturer and approved for use with this product. An optional 0dB coax wire antenna may be supplied. For other antenna options, please contact OMNEX Control Systems ULC

Mounting and Installation

The receiver can be mounted by fastening two ¼" bolts through the two mounting holes in the unit's enclosure. When mounting, ensure that the receiver is oriented so that the text is reading right and the connector is "down".

When selecting a mounting point for the receiver, it is recommended that the location require only a minimal length of wiring to connect it to the control panel, that it will be in a visible area where it has good exposure to the operator and that it is mounted on a surface that is protected from the weather and sustains minimal vibration. It is also recommended that the receiver have the best possible line of sight with the transmitter for maximum operating range.

Power Connections and Wiring

Whenever a power connection is made to an electronic device, it is a good practice to make both the Power (+) and Ground (-) connections directly to the Battery and avoid connecting the power from the charging side of existing wiring or making use of existing "ACC" or other peripheral connection points.

Make sure that wire of sufficient gauge and insulator type is used when connecting the outputs of the receiver to the control panel. Observe any component manufacturer's instructions and recommendations for proper integration of their product. This includes the power ratings and requirements of such components as relays, valves, solenoids, etc.

Be sure to test each of the outputs with a multi-meter prior to connecting the outputs to your end devices. This will ensure that each output has been programmed to operate in the manner required by each end device.

Filtering and Noise Suppression

Whenever a solenoid or electromagnetic switch is controlled by the receiver, it is a good practice to install a Diode across its terminals to ensure that surges and spikes do not continue back into the circuit. Appropriate 36V Bi-directional Diodes kits can be ordered under the OMNEX part number "AKIT-2492-01".

Power the Transmitter

1. Install Batteries

Remove the battery cover on the back of the transmitter using a slotted screwdriver and insert 4 "AA" alkaline batteries. Orientation of the batteries is embossed inside the battery housing.



T110 Battery Housing

2. Turn on the Transmitter

Refer to the **Light Legend** below for diagram details.

1. Press Power [ON]

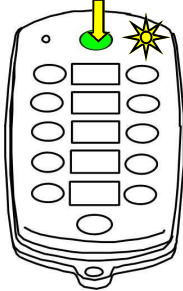

WARNING: do not install batteries backwards, charge, put in fire, or mix with other battery types. May explode or leak causing injury. **Replace all batteries at the same time as a complete set and do not mix and match battery types.**

NOTE: For operation at temperatures below -10°C lithium batteries are recommended. Low temperatures reduce battery performance for both alkaline and lithium types. Refer to the battery manufacturer's specifications for detailed information on low temperature performance.

If the transmitter's (Active) light does not flash, check the battery orientation.

To turn off the transmitter, press the Power [OFF] button.

Test the Transmitter / Receiver Link

Follow these steps to ensure that there is a radio link between the transmitter and receiver.
Refer to the **Light Legend** below for diagram details

1. Power R160

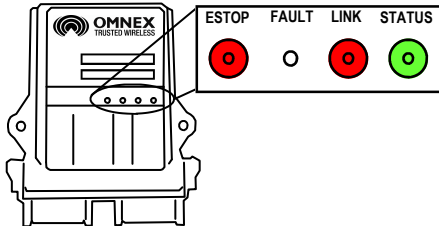

2. Power T110

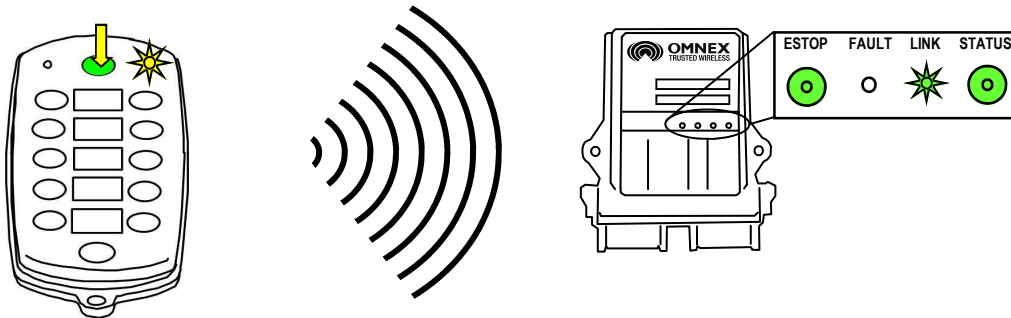

NOTE: The transmitter will shut itself off (and the receiver will then shut off all outputs) after 10 minutes of inactivity as a battery saving feature. Momentarily operating any button on the transmitter, including the [Power] button will restart the 10 minute timer.

The ORIGA System is now ready for use.

If the receiver's (Link) light does not become GREEN follow the steps under **Download ID Code**.

Light Legend	Solid	Slow Flash	Fast Flash	Red Light	Green Light	Yellow Light	Alternating Red & Green Light

Download ID Code (Use in case of Link Test failure)

Follow these steps to download the transmitter's unique ID Code into the receiver. This will allow the receiver to establish a radio link with a specific transmitter. Refer to **Troubleshooting Chart #4** for Tips and Considerations

NOTE: It is necessary to download the ID Code when replacing either the transmitter or the receiver.

1. Opening the R160 Case

The cap is held on by two plastic tabs at opposing sides, which can be unlatched as shown using a screwdriver. Once the cap is free, the R160 can slide open.

Use a small slotted screwdriver to press the Side Tabs inward.

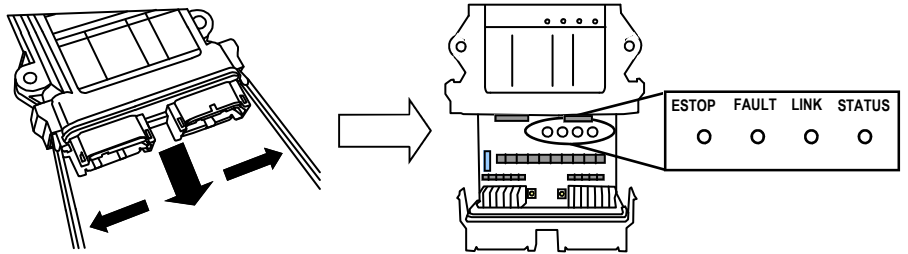

2. Power R160

A. Supply power to the receiver. The (E-Stop) light and the (Link) light will come on RED and the (Status) light will come on GREEN

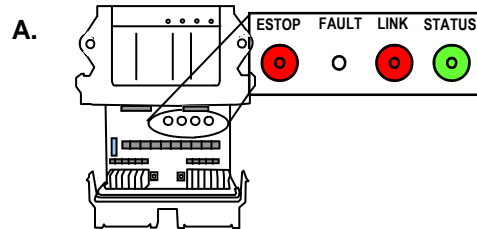

3. Power T110 into Configuration Mode

- A. Press and Hold Power [OFF]
- B. Press and Hold Power [ON]
- C. Release Power [OFF] button
- D. Release Power [ON] button

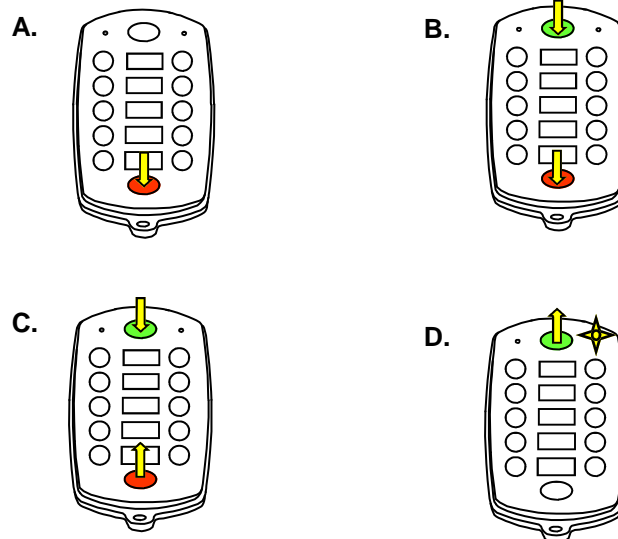

Light Legend

Solid	Slow Flash	Fast Flash	Red Light	Green Light	Yellow Light	Alternating Red & Green Light
-------	------------	------------	-----------	-------------	--------------	-------------------------------

Download ID Code (Use in case of Link Test failure)

4. Put R160 into Setup Mode

- A. Press & hold [Setup] button until (Status) light goes from slow flash to fast flash
- B. Release [Setup] button. (Status) light goes to solid GREEN, (Link) light turns off

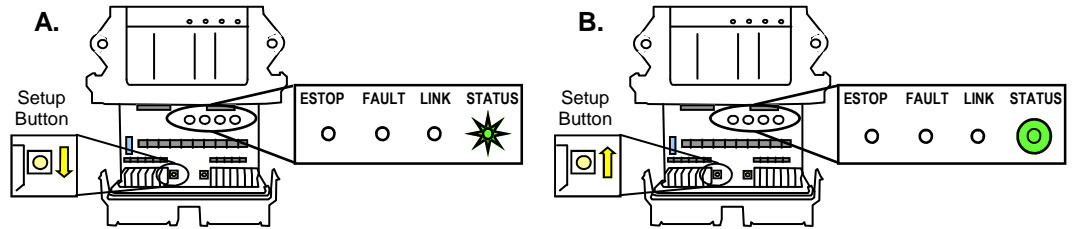

NOTE: If left idle in Setup Mode for over 30 seconds, the receiver will time out. The (Link) light and (Status) light will flash RED rapidly. To return to Setup Mode, repeat step 4.

5. Send Code

NOTE: When downloading a new ID to a receiver, a safety feature requires that the transmitter be in close proximity to the receiver. This will prevent a transmitter from accidentally reprogramming a different receiver in the area.

- A. Press Power [ON] button to send code

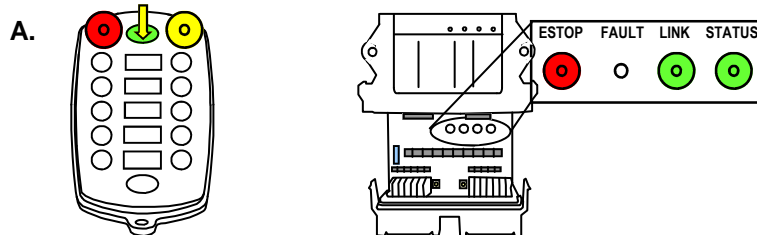

Once the ID Code has been downloaded, the RED (Battery) light and the YELLOW (Active) light on the transmitter will go out. The (Link) light on the receiver will change from GREEN to RED.

NOTE: When replacing the receiver cover, ensure the cover snaps completely into place to create a weather proof seal around the base of the receiver.

Light Legend

Solid		Slow Flash		Fast Flash		Red Light		Green Light		Yellow Light		Alternating Red & Green Light	
-------	--	------------	--	------------	--	-----------	--	-------------	--	--------------	--	-------------------------------	--

Changing Start Up and Shutdown Configuration

The T110/R160 system has 3 available startup and shutdown modes that can be configured with the following steps.

1. Opening the R160 Case and Power R160

- The cap is held on by two plastic tabs at opposing sides, which can be unlatched as shown using a screwdriver. Once the cap is free, the R160 can slide open.
- Supply power to the receiver. The (E-Stop) light and the (Link) light will come on RED and the (Status) light will come on GREEN

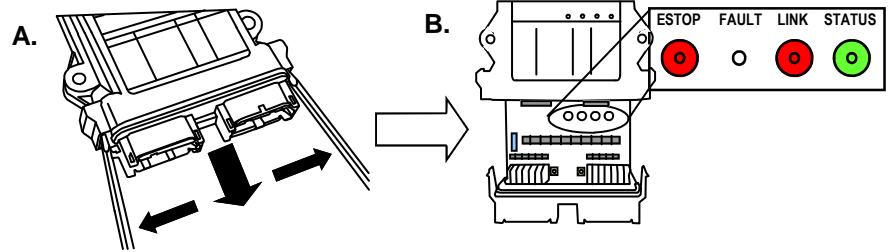

2. Power T110 into Configuration Mode & Enter Configuration Password

- Power T110 into configuration mode by following Step #3 from **Download ID Code**
- Press function buttons in order 3, 1, 4, 2
- Press Power [ON] button

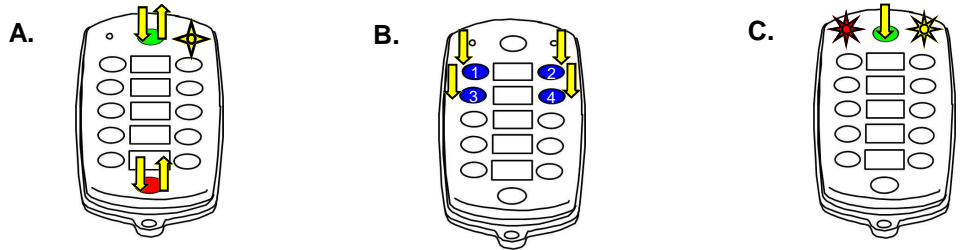

3. Enter Start Up and Shut Down Code

Enter the 10-digit Configuration Code associated with one of the following startup and shutdown modes:

ON / OFF Mode	1188888888	ON normal. OFF when T110 / R160 link is lost.
Secure Mode	4188888888	ON by entering the "3, 1, 4, 2" password on the T110 and pressing the GREEN [Power] button. OFF when T110 / R160 link is lost.
Auto Power Down Mode	5188888888	ON normal. OFF when T110 / R160 link is lost or after 10 minutes of being idle.

4. Put R160 into Setup Mode

- Press & hold [Setup] button until (Status) light goes from slow flash to fast flash
- Release [Setup] button. (Status) light goes to solid GREEN, (Link) light turns off

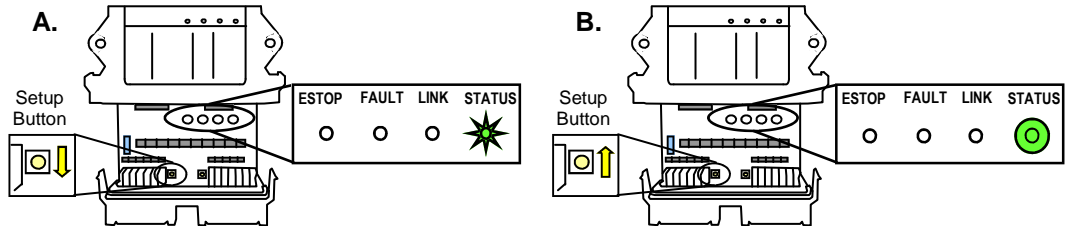

NOTE: If left idle in Setup Mode for over 30 seconds, the receiver will time out. The (Link) light and (Status) light will flash RED rapidly. To return to Setup Mode, repeat step 4.

5. Send Code

- Press Power [ON] button to send code

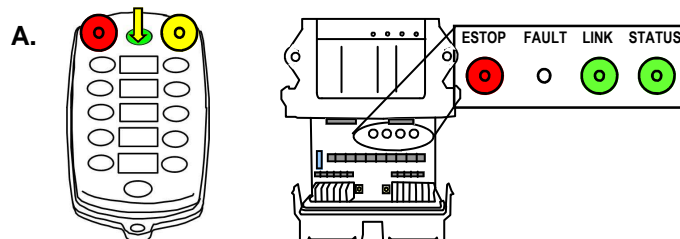

Once the ID Code has been downloaded, the RED (Battery) light and the YELLOW (Active) light on the transmitter will go out. The (Link) light on the receiver will change from GREEN to RED.

Light Legend	Solid	Slow Flash	Fast Flash	Red Light	Green Light	Yellow Light	Alternating Red & Green Light
--------------	-------	------------	------------	-----------	-------------	--------------	-------------------------------

Diagnostics—T110 Transmitter

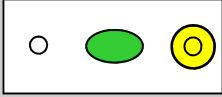
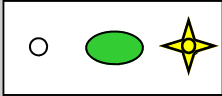
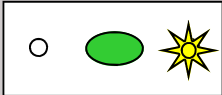
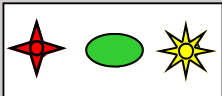
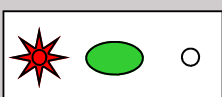
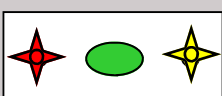
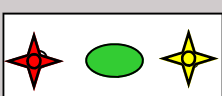
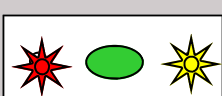
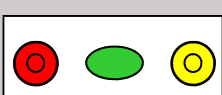
Indicator Lights	Description	Solution
	Occurs when ever a function is pressed. Will also remain on momentarily on Power Up.	N/A
	Transmitter is in Download mode.	To take it out of Download mode turn transmitter off and turn it back on again.
	Transmitter is in Operating mode.	N/A
	Low Battery.	Change Batteries Note: <i>Low batteries will last approximately 8 hours once the Low Battery light begins to flash. Replace batteries during next break.</i>
	Fast Flash for approx. 10 seconds indicates T110 failure.	Send the unit in for service.
	Stuck button detected.	Toggle the buttons a few times. Call for service. Send the unit in for service.
	On Power Down Unit is still powered, likely due to an on function or stuck button.	Toggle the buttons a few times. Call for service. Send the unit in for service.
	Transmitter is in Configuration mode.	To take it out of Configuration mode turn transmitter off and turn it back on again.
	Transmitter is downloading ID Code.	Wait for approximately 5 seconds. Once the download is complete the transmitter will automatically shut off.

Light Legend	Solid 	Slow Flash 	Fast Flash 	Red Light 	Green Light 	Yellow Light 	Alternating Red & Green Light 
---------------------	---	--	--	---	---	--	---

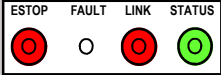
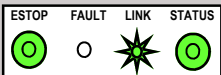
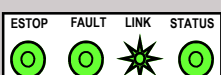
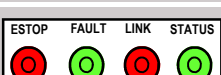

Diagnostics - R160 Receiver

Normal Operation

	<p>Transmitter is OFF If the transmitter is off, the receiver is operating properly.</p>
	<p>Transmitter is ON When the transmitter is turned on, the Link light (fast flashing) and E-Stop (GREEN) indicates the receiver is operating properly</p>
	<p>Transmitter is in Operation When a function is activated on the transmitter, the Fault light will turn on GREEN. This indicates the receiver is operating properly</p>
	<p>Transmitter is OFF When a latched function is activated then the transmitter is turned off, the Fault light will stay on GREEN. If the system was intentionally designed this way, the receiver is operating properly, if not call for service.</p>

Trouble Indicators

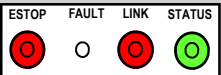
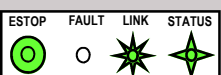
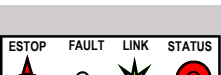
Note: In some cases, the indicator lights will be different depending on whether the transmitter is on or off. Please note the transmitter status in the "Description" column for each case.

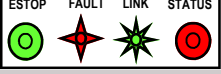
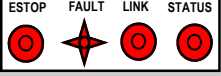
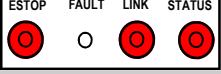
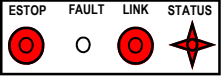
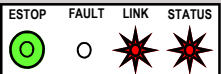
Indicator Lights	Description	Solution
	<p>Transmitter is ON The reason is the transmitter is not communicating with the receiver.</p>	Refer to Troubleshooting Chart #3 for solutions
	<p>Transmitter is ON A low battery condition has been detected.</p>	To detect intermittent conditions caused by poor or corroded ground or power circuits, the GREEN light will continue to flash for 30 seconds after the condition has been removed.
	<p>Transmitter is ON An internal fault with the E-Stop has been detected.</p>	<p>Inspect E-Stop wiring for short circuit. Disconnect E-Stop wire as close to the receiver output as possible. If the Status light changes to:</p> <ul style="list-style-type: none"> • GREEN, a short occurs after disconnection point. • Stays flashing RED, send it in for service .
	<p>Transmitter is ON A short to ground or excessive current draw on an output. It is most likely caused by a wiring fault.</p>	<p>Ensure transmitter is functioning properly, check status of each output connection: Press each function button and observe Fault Light.</p> <ul style="list-style-type: none"> • If GREEN, everything is OK. • If RED, there is a short in that connection.
	<p>Transmitter is ON The E-Stop output has been connected with one of the other outputs</p>	Follow the wire and check for connections with other wires, disconnect to see if condition clears. If not, call for service.
	<p>Transmitter is OFF A wiring short to the battery has been detected.</p>	Refer to Troubleshooting Chart #1 for solutions
	<p>Transmitter is OFF The receiver has detected an internal fault.</p>	Refer to Troubleshooting Chart #1 for solutions
	<p>Transmitter is OFF Blown fuse detected.</p>	Refer to Page 6 for instructions on how to open the receiver case to access fuse. Check wiring for shorts or bare spots. If fuses continue to blow, call for service.
	<p>Transmitter is ON A setup failure has occurred.</p>	Either hold the Setup button for 5 seconds to return to Setup mode or cycle power to return to the normal operating mode.
	<p>Transmitter is OFF The receiver is powered incorrectly.</p>	Most likely cause of this condition is that an output wire or the E-Stop wire has been connected to the power supply while the power wire is disconnected from the power supply.

Light Legend	Solid 	Slow Flash 	Fast Flash 	Red Light 	Green Light 	Yellow Light 	Alternating Red & Green Light 
---------------------	---	--	--	---	---	--	---

Test the Receiver—R160

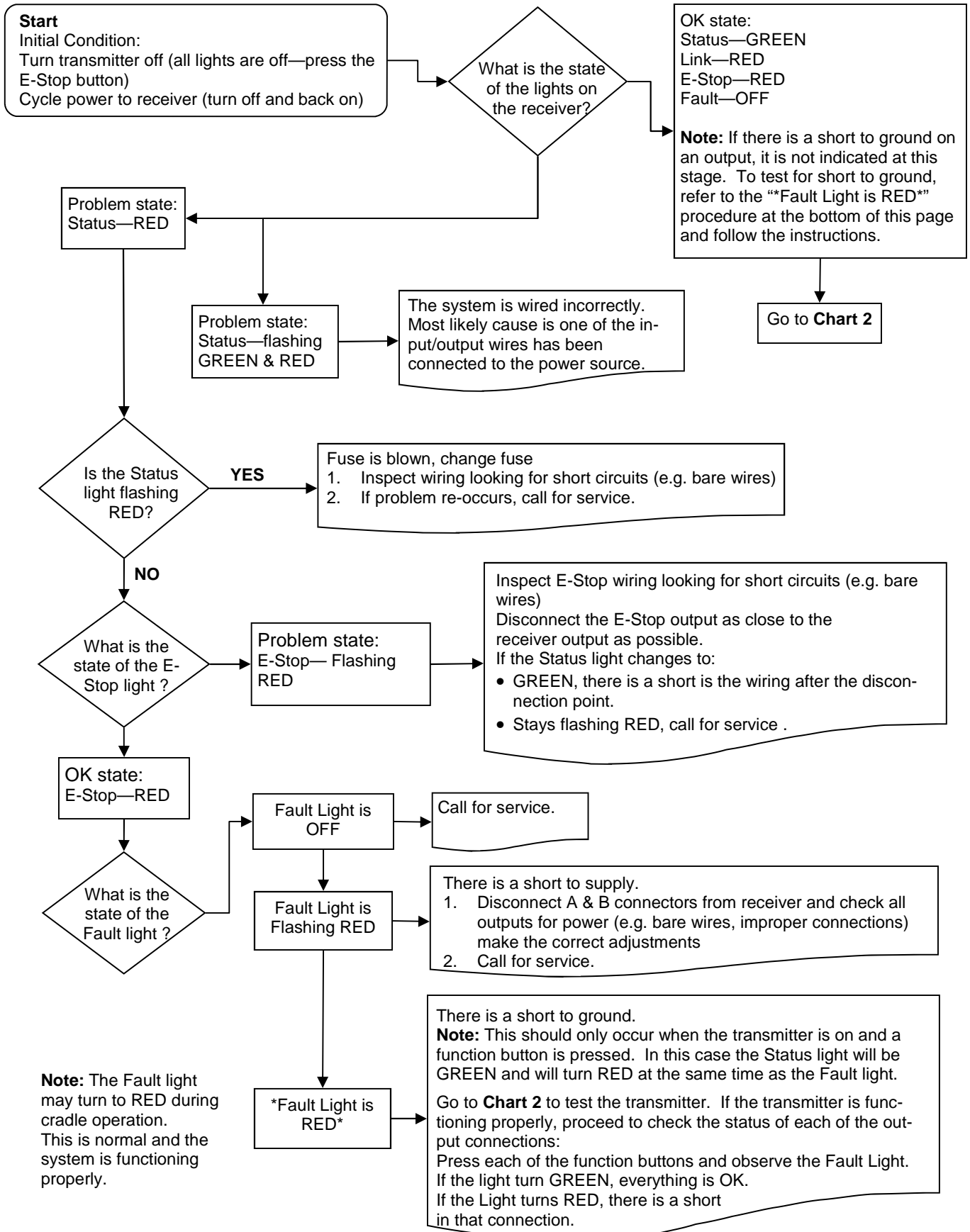

Note: The Fault light may turn to RED during cradle operation. This is normal and the system is functioning properly.

Test the Transmitter—T110

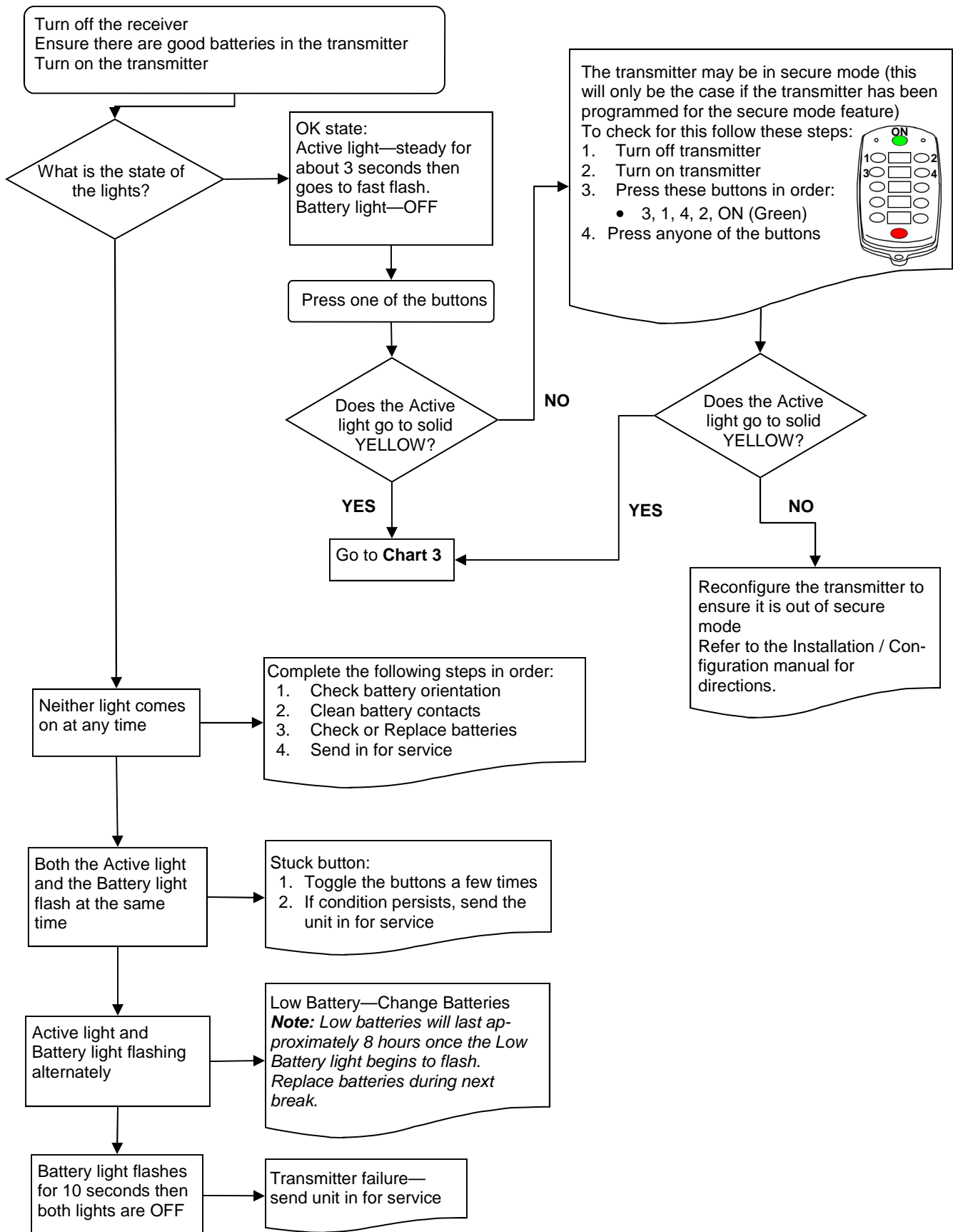

Testing the Transmitter / Receiver Communication

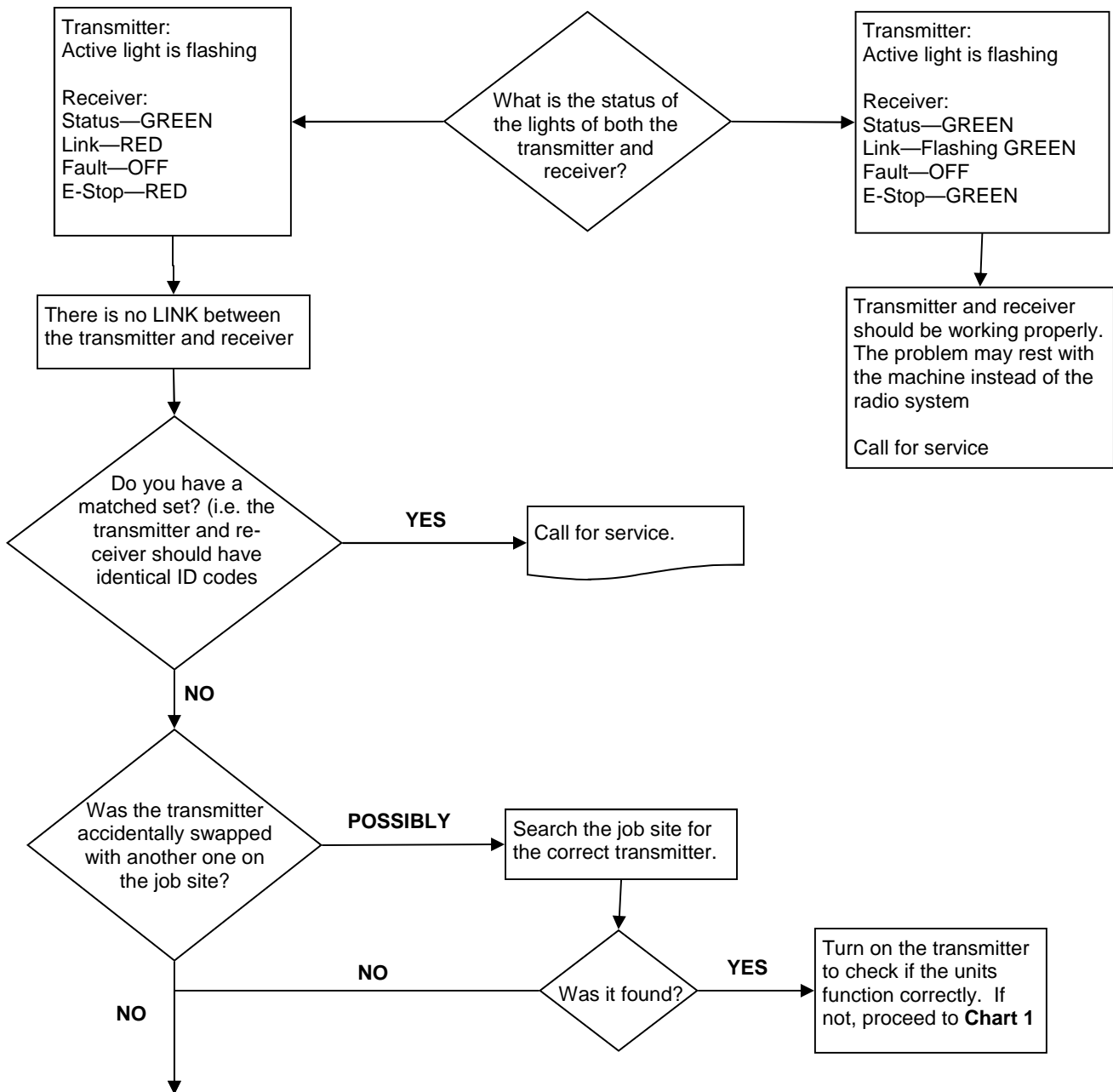

!!Caution!!

Note: Before you proceed with the Download ID procedure located on **Page 7**, great care and caution must be adhered to. Also, refer to **Chart #4** for Tips and Considerations.

If by accident, the transmitters have been switched with another unit, by downloading the ID code to a new receiver, it is possible for the transmitter to operate 2 units at the same time (if the original receiver unit is still on the job site). Therefore it must be certain that the transmitter / receiver pair are the correct set.

Secondly, once the download procedure is completed, ensure all other units on the job site are stopped. Test the operation of the newly configured set to ensure no other machines on the site work with the same transmitter.

Once you are certain that the transmitter / receiver pair are a unique set, continue normal operations.

Considerations when Downloading the ID

Potential downloading issues

If testing of the receiver and transmitter both show the system as working (Chart 1 & 2), then the transmitter and receiver will both go into Download/Configuration mode.

Possible issues could arise during Step 4, the download phase of reprogramming. In this case there are 2 symptoms to look for:

1. The Link light on the receiver will not turn GREEN when the power switch is toggled on the transmitter to download
2. The receiver will "time out" indicating that it didn't receive a signal from the transmitter within the 30 seconds from the time the receiver was put into Setup Mode.

If all indications appear normal during the download phase, test the link by turning on the transmitter (note: the transmitter shuts off after transmitting the ID code in Step 4)

1. If the Link light on the receiver doesn't turn GREEN, the receiver didn't receive all of the information that was sent from the transmitter.

Possible Solutions

1. Try the Downloading steps again
2. If this doesn't correct the problem, send both the transmitter and receiver in for service.

Note: you could try to determine whether the fault lies with the transmitter or receiver by completing the Reprogramming procedure with a different transmitter. If this step works, then the fault lies with the original transmitter. If not, the fault may lie with the receiver.

!!Caution!!

Note: Before attempting reprogramming with another transmitter, understand that reprogramming the receiver with another transmitter, could result in two receivers on the job site responding to the one transmitter. If the original transmitter was sent in for repair, disconnect the receiver (disconnect connector A) to continue using the machine without remote capability and without fear of inadvertently operating the machine with the other transmitter.

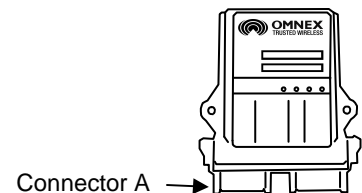

Reprogramming Tips:

1. Be patient and deliberate when pressing the Power and E-Stop buttons in the correct order during power up in Configuration mode
2. Use a pointy instrument to depress the Setup button on the receiver (i.e. a pen) as the button is relatively small
3. Follow each step as laid out in the procedure
4. Never lay the receiver circuit board down on anything metallic (there are contact points on the back which could contact the metal and damage the receiver)

Parts & Accessories

Part	OMNEX Part Number	Description
Batteries	B0010	4 x AA alkaline
Fuse	F0039	36V Bi-directional, Bussman ATC-15
Belt Clip	AKIT-2428-03	see illustration below
Magnets	AKIT-2428-01	see illustration below
Bipolar Diode Kit	AKIT-2492-01	Motorola P6KE36CA
Dash Cradle	Call OMNEX	see illustration below
R160 Output Cable	ACAB-2493-01	Generic Output Cable- see illustration below
Connector Kit	AKIT-2337-01	Includes Deutsch socket connectors, wedges, pins and sealing plugs
Keypad Label T110	FLBL-1726-25	Generic Line Pump Labels



Dash Cradle



Belt Clip



Magnets



R160 Output Cable

Specifications

	R160 Receiver	T110 Transmitter
Size	5.1" x 4.7" x 1.4" (130mm x 119mm x 36mm)	5.8" x 3.4" x 1.2" (147mm x 86mm x 30mm)
Weight	0.65lbs (0.295kg)	.65 lbs (295g) incl. batteries
Construction	High impact plastic, weatherproof	High impact, low temperature plastic, weatherproof
Input Power	+9V to 30VDC	4AA alkaline batteries
Battery Life	N/A	160 hours (continuous use)
Operating Temperature Range	-40F to 158F (-40C to 70C)	-22 F to +140 F (-30 to +60 C)
Outputs	3A (max) each (sourcing), 10A (max) each (combined)	N/A
Antenna	Internal	Internal
Approvals	USA- FCC part 15.247 Canada- ISC RSS 210 Issue 6, Sept. 2005 Europe- CE, EN 440 Australia- C-Tick	

FCC Rules and Compliance

This device complies with Part 15 of the FCC Rules. Operation is subject to the following two conditions: (1) This device may not cause harmful interference, and (2) this device must accept any interference received, including interference that may cause undesired operation.

FCC Part 15.247
ISC RSS 210 Issue 6, Sept. 2005

Warranty

OMNEX Control Systems ULC warrants to the original purchaser that the OMNEX products are free from defects in materials and workmanship under normal use and service for a period of ONE YEAR, parts (EXCLUDING: SWITCHES, CRYSTALS, OR PARTS SUBJECT TO UNAUTHORIZED REPAIR OR MODIFICATION) and labor from the date of delivery as evidenced by a copy of the receipt. OMNEX's entire liability and your exclusive remedy shall be, at OMNEX's option, either the (a) repair or (b) replacement of the OMNEX product which is returned within the warranty period to OMNEX freight collect by the OMNEX APPROVED carrier with a copy of the purchase receipt and with the return authorization of OMNEX. If failure has resulted from accident, abuse or misapplication, OMNEX shall have no responsibility to repair or replace the product under warranty. In no event shall OMNEX be responsible for incidental or consequential damage caused by defects in its products, whether such damage occurs or is discovered before or after replacement or repair and whether or not such damage is caused by the negligence of OMNEX Control Systems ULC.

OMNEX Control Systems ULC

74-1833 Coast Meridian Road
Port Coquitlam, BC, Canada
V3C 6G5

Tel: 604-944-9247
Fax: 604-944-9267

Toll Free: 1-800-663-8806

www.omnexcontrols.com